

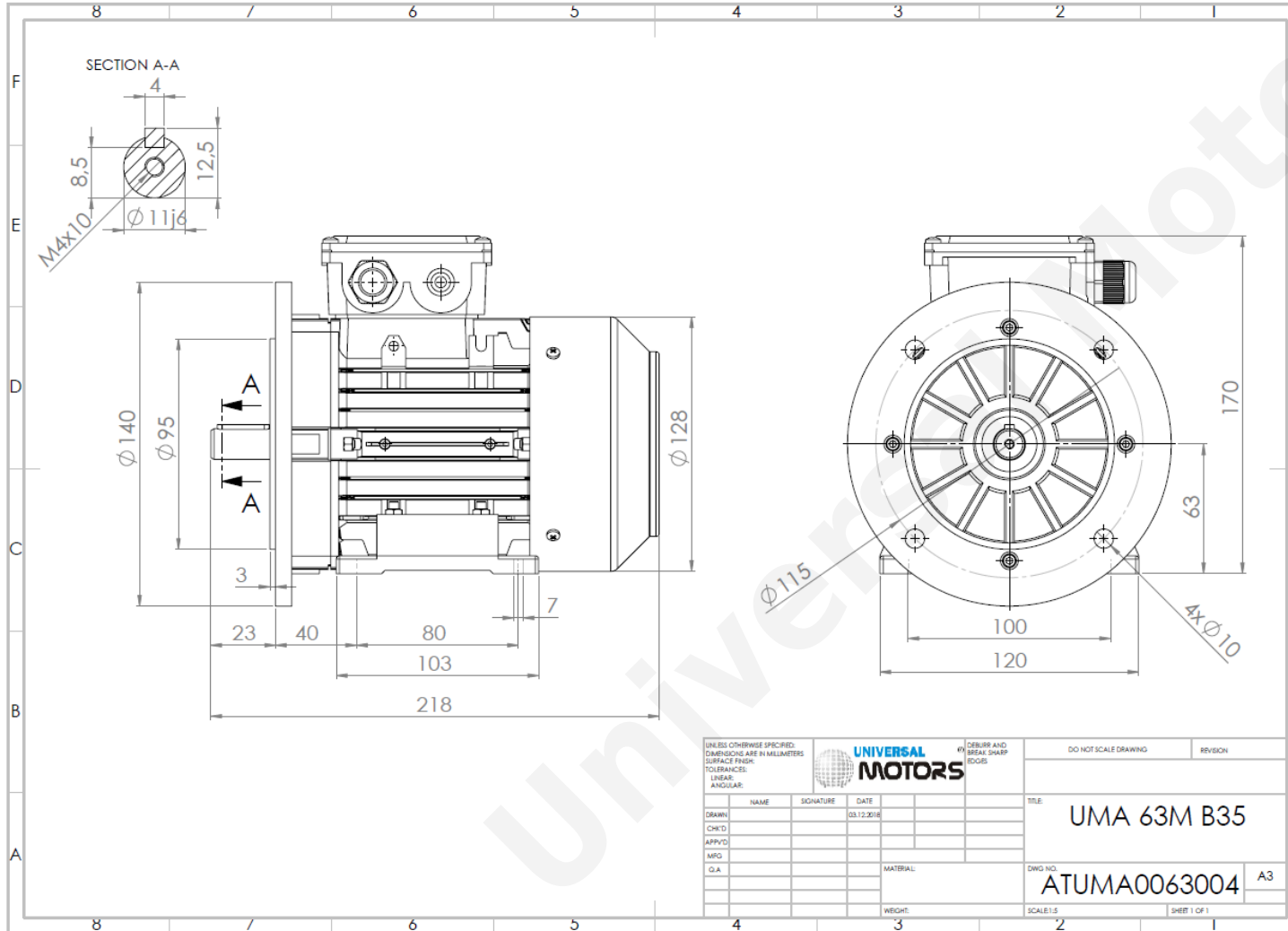

TECHNICAL DATA

Three Phase Electric Motors - Aluminum Frame
 UM2A 63M2-4
 0.18 kW / 0.25 Cv
 1350 RPM



Motor type:	UM2A 63M2-4
Output:	0.18 kW / 0.25 Cv
Speed (min ⁻¹):	1350 RPM
Frequency:	50 Hz
Voltage:	400 V
Current:	0.55 A
Power factor (Cos Ø):	0.73
Poles:	4
Insulation class:	F
Temperature rise Class:	B
Efficiency 50%:	60.3 %
Efficiency 75%:	64.9 %
Efficiency 100%:	64.7 %
Torque:	1.25 N.m
Tstarting/Tnominal:	2.0
Istarting/Inominal:	3.6
Tmaximum/Tnominal:	2.1
Noise:	52 Db(A)
Weight:	4.0 Kg
Bearing DE:	6201 2Z
Bearing NDE:	6201 2Z

Regime - S1

Altitude - 1000m

Environment Temperature - 40°C

CONTACTS:

UNIVERSAL MOTORS Tel: +351 252 299 080
 Rua de São Brás,745 Fax: +351 252 299 089
 4480-782 VILA DO CONDE Mail: geral@universalmotors.pt

* References applied only in the UK